



10-12. August 2023.

FIM BAJA WORLD CUP

SUPPLEMENTARY REGULATIONS

CONTENTS

INTRODUCTION	3
PROGRAMME	3
1. DESCRIPTION	5
2. ORGANIZATION	6
3. ENTRIES	7
4. INSURANCE	8
5. ADVERTISING / IDENTIFICATIONS	9
6. TYRES	9
7. FUEL	10
8. ADMINISTRATIVE CHECKS	10
9. TECHNICAL SCRUTINEERING, SEALING AND MARKING	10
10. START OF THE EVENT	12
11. RUNNING OF THE EVENT	12
12. FIXED PENALTY	13
13. SERVICE PARK	14
14. FINAL CHECKS / PROTEST / APPEALS	15
15. RESULTS	15
16. PRIZES	15
APPENDIX 1. – COMPETITOR RELATIONS OFFICERS	16
APPENDIX 2. – TIMETABLE	17
APPENDIX 3. – INSTRUCTION FOR GPS TRACKING SYSTEM	19
APPENDIX 4. – GPS TRACKING SYSTEM KIT COMPONENTS	31
APPENDIX 5.– INFORMATION NOTICE FIM RIDERS' INSURANCE PROGRAMME 23-24	34
APPENDIX 6. – SPORTITY APP / DIGITAL NOTICE BOARD	37
APPENDIX 7. – ITEMS AT ORGANIZER'S DISCRETION	38

INTRODUCTION

Name of the event: **XX.HunGarian Baja**

Date of the event: 10-12.August.2023.

Preamble:

„XX.Hungarian Baja” will be run in compliance with:

- **FIM Baja World Cup Sporting Regulations**
 - **FIM Rallye Raid Championship Regulations (v.27.06.2023)**
 - **FIM Baja World Cup Technical Regulations (v.09.03.2023)**
 - **FIM Sporting Code**
 - **FIM Disciplinary & Arbitration Code**
 - **FIM Medical Code**
 - **FIM Anti-Doping Code**
 - **FIM Environmental Code**
 - **FIM Code of Ethics**
- Present Supplementary Regulation and its appendices /SR/
 - Official Bulletins
 - Traffic regulations of Hungary

The current FIM Regulations & Codes are available on: <https://www.fim-moto.com/en/documents>

Any modifications, amendments and/or additions to the Rules and Regulations shall be made in the form of numbered and dated bulletins. Additional information will be published in the **Baja** Guide on 01.06.2023 on the official website: www.hungarianbaja.com

HunGarian Baja is the 5th Round of the FIM Bajas World Cup 2023.

Modifications, amendments and/or changes to this Supplementary Regulation will be announced by numbered and dated bulletins (issued by the Organizer and approved by the FIM and National Motorsport Federation of Hungary (MAMS) up to the time of the first Jury meeting and thereafter by the FIM International Jury.

Shall the Championship host a Support Race and since the Fédération Internationale de Motocyclisme (FIM) is not in any way involved in the organisation of Support Race, this Support Race will be organised without any commitment nor responsibility for the FIM and is under the sole authority and responsibility of the relevant National Federation and/or the local organiser (MAMS). See below:

The International Open Baja Cup (Bike, Quad), with separate regulations, starting after all FIM competitors, using the same special stages in the same time.

The official time will be as GPS (Hungarian time = CET = GMT + 2).

MAIN LOCATIONS:

REGISTRATION	TESCO parking lot 8100 Várpalota, Fehérvári str. 17.	N47°12'00 E18°09'08
SERVICE PARC M/Q	GÁL GYULA SPORS HALL parking lot 8100. Várpalota, Fehérvári str. 9.	N 47°11'59.4132" E 18°8'48.7926"
BAJA OFFICE HQ	THURY CASTLE 8100. Várpalota, Hunyadi Mátyás Square 1.	N47°12'05 E18°08'20
SCRUTINEERING	TESCO 8100. Várpalota, Fehérvári str. 17.	N47°12'00 E18°09'08
PARC FERMÉ	VÁRPALOTA FŐTÉR 8100. Várpalota, Szabadság Square	N47°11'58 E18°08'26

LENGHT OF SELECTIVE SECTIONS

Stage 1:	221,32	km
Stage 2:	245,60	km
TOTAL	466,92	km

Overall SS distance and total distance of the itinerary

Number of Stages	2
Number of Sections	5
Number of Selective Sections	5
Total distance of the itinerary	633,37 km

Route terrain on Selective Sections:

Gravel/dirt tracks	100	%
--------------------	-----	---

PROGRAMME

Date:	Time:		Location:
14.06.2023	10:00	Publishing of the supplementary regulations	
01.06.2023	10:00	Entries open	www.hungarianbaja.com
07.06.2023	16:00	Issuing of Baja Guide	
10.07.2023	24:00	Closure date of entries at reduced fees	www.hungarianbaja.com
01.08.2023	24:00	Closure date of entries	www.hungarianbaja.com
01.08.2023	24:00	Closing date for order of extra service in SP	info@hungarianbaja.com
01.08.2023	24:00	Closing date for shakedown registration	
02.08.2023	16:00	Publication date of entry list	Sportity, www.hungarianbaja.com
02.08.2023	10:00	Press conference before the Baja	Thury Castle, Várpalota
09.08.2023	16:00-20:00	Registration, Check List and Service Plate delivery	TESCO, Várpalota
10.08.2023	07:00-18:00	Registration, Check List and Service Plate delivery	TESCO, Várpalota
10.08.2023	08:00-15:00	Administrative checks	Thury Castle, Várpalota
10.08.2023	08:00	Collection of material and documents	Thury Castle, Várpalota
10.08.2023	08:00	Collection of Baja safety tracking system	Thury Castle, Várpalota
10.08.2023	08:00	Collection of navigation GPS (NAV-GPS)	Thury Castle, Várpalota
10.08.2023	08:00-16:00	Scrutineering – sealing & marking of components	TESCO, Várpalota
10.08.2023	08:00	Opening of media centre	Thury Castle, Várpalota
10.08.2023	11:00-14:00	Shakedown	Várpalota, according to SD Roadbook
10.08.2023	15:00-18:30	Parc-Fermé	Várpalota, Szabadság Square
10.08.2023	19:00	Team managers and/or Drivers' briefing Issuing of the road book (Stage 1)	Thury Castle, Várpalota
10.08.2023	20:00	Publication of start list for Ceremonial Start	DNB
10.08.2023	20:00	Publication of list of vehicles eligible to start	DNB
10.08.2023	20:00	Publication of start list for Stage 1	DNB
10.08.2023	21:00	Ceremonial Start	Thury Castle, Várpalota
11.08.2023	09:30	Start of the Baja – Stage 1, Section 1 (TC0) Prologue	Thury Castle, Várpalota
11.08.2023	10:33	Finish of Section 1 (estimated time of 1 st vehicle)	Thury Castle, Várpalota
11.08.2023	10:35	Publication of start list	SPORTITY
11.08.2023	10:40	Start of Stage 1, Section 2 (estimated time of 1 st vehicle)	Thury Castle, Várpalota
11.08.2023	18:43	Finish of Stage 1 (estimated time of 1 st vehicle)	Thury Castle, Várpalota
11.08.2023	20:30	Publication of start list for Stage 2	DNB
11.08.2023	09:30	Start of the Baja – Stage 1, Section 1 (TC0) Prologue	Thury Castle, Várpalota

12.08.2023	08:00	Start Stage 2 (estimated time of 1 st vehicle)	Thury Castle, Várpalota
12.08.2023	15:13	Finish of Stage 2 (estimated time of 1 st vehicle)	Thury Castle, Várpalota
12.08.2023	15:30	Final scrutineering; Immediate after arrival in the finish (following the marshals' instructions)	MÁRIA GUMI, Várpalota
12.08.2023	17:00	Publication of Provisional Classification	DNB
12.08.2023	17:30	Publication of Final Classification; After the Jury have declared the Classification final.	DNB
12.08.2023	18:00	Podiums Ceremony / Prize-giving	Thury Castle, Várpalota
12.08.2023	20:30	XX-th Hungarian Baja jubilee Party	Thury Castle, Várpalota

1. DESCRIPTION

1.1 PLACES, AND DATE OF THE EVENT:

PLACE: Várpalota, Hungary

DATE: 10-12. August 2023.

1.2 TITLES FOR WHICH THE HUNGARIAN BAJA COUNTS:

FIM Bajas World Cup and International Open Baja Cup (2023)

MAMS International Open Baja Cup, with International Participants

1.3 VISA NUMBERS:

MAMS Nr: MAMS/049/2023

EMN Nr: 34/325

IMN Nr: **814/05**

1.4 LOCATION OF BAJA OFFICE:

From 14.06.2023

GARILLA RACING KFT.

H- 8200 Veszprém, Házgyári str.1.

Tel: +36-30-791-4270

e-mail: info@hungarianbaja.com

web: www.hungarianbaja.com

From 10.08.2023

Thury Castle, Hunyadi Mátyás Tér 1., 8100 Várpalota

GPS COORDINATE: N47°12'05 E18°08'20

1.5 LOCATION START AND FINISH:

Várpalota Főtér, Szabadság Tér.

1.6 PRESS OFFICE OPENING SCHEDULE:

LOCATION: Thury Castle, Hunyadi Mátyás Tér 1., 8100 Várpalota

TIME: Friday 11. August 2023 08:00-21:00 hrs

Saturday 12. August 2023 08:00-20:00 hrs

1.7 LOCATIONS OF NOTICE BOARD:

Digital Notice Board (DNB): [Sportity](https://sportity.com), www.chromomoto.hu, www.hungarianbaja.com



On PC: https://webapp.sportity.com/channel/HGB23_FIM

See appendix 6.

1.8 LOCATION PARC FERMÉ:

Várpalota Főtér GPS COORDINATE: N47°11'58, E18°08'26
Szabadság Tér, 8100 Várpalota

1.9 LOCATION SERVICE PARK:

GÁL GYULA SPORS HALL parking lot
8100. Várpalota, Fehérvári str. 9. GPS COORDINATE: N 47°11'59.4132" E 18°8'48.7926"

2. ORGANIZATION

2.1 ORGANIZER'S NAME:

Name of the organizers: **Garilla Racing Kft. and Garzone s.r.o.**
Name of the National Sporting Authority: **MAMS** (National Motorsport Federation of Hungary)

2.2 ADDRESS & CONTACT DETAILS:

GARILLA RACING KFT. H- 8200 Veszprém, Házgyári str. 1.
e-mail: info@hungarianbaja.com
web: www.hungarianbaja.com

2.3 ORGANIZING COMMITTEE:

Patron of the Event: Mrs. Márta CAMPANARI-TALABÉR
Mayor of Várpalota
Mr. Csaba KATONA (Vice Mayor of Várpalota)
President of the Organizing Committee Mr. Zoltán GARAMVÖLGYI
Members of the Organizing Committee Mr. Ferenc SCHEIBENHOFFER
Mr. Sándor NÉMETH

2.4 JURY OF THE MEETING:

President of the Jury (FIM) Mr. Jean-Luc MAINDRON Lic. N° 16775
Member of the Jury (FIM) Mr. Daniele COTTO Lic. N° 16658

Whithout voting rights:

Member of the Jury (MAMS) Mrs. Brigitta VARGA
National Lic. n°23SF0026

2.5 OBSERVERS and DELEGATES:

Technical Director (FIM) Mr. Antonio PEGO Lic. N° 14828

2.6 SENIOR OFFICIALS:

Clerk of the Course	Mr. János FALICS	Lic. 15373 Super Lic. 16705
Deputy of Clerk of the Course	Mr. Richard KELEMEN	National Lic. n° 2357-0023
Environmental Steward	Mr. Péter BAKÓ	Lic. N° 14787
Chief Technical Steward	Mr. Gábor FARKAS	Lic. N° 14834
Chief Safety Officer	Mr. Sándor NÉMETH	
Deputy of Safety Officer	Mr. Ferenc SCHEIBENHOFFER	
	Mr. Ádám TÓTH	
	Mr. László BALOGH	
	Mr. Zsolt TÓTH	
	Mr. Zsolt MICZINGER	
Chief Medical Officer	Dr. Zoltán PÁLL	Lic. N° 16320
Timekeeping and Results Officer	Mr. Csaba GLÜCK	
Crews' Relations Officer	Mr. István MÁTRAI	
GPS Control	STELLA	
Secretary of the Baja	Ms. Julianna TÖRÖK	
Secretary to the Jury	Mrs. Éva FALICS	
Press Relations Officers	Ms. Anita TÓTH	
Responsible for the Road Book	Mr. László POLGÁR	
Responsible for checking the Road Book	Mr. Péter FALUVÉGI	

2.7 IDENTIFICATION OF OFFICIALS:

Competitors Relation Officer	"CRO" Pink tabard
Scrutineers	"ATB" Blue tabard or shirt
Post Chiefs:	"VEZETŐBÍRÓ" Red tabard
Special Stage Commanders:	"VEZETŐBÍRÓ" Red tabard
Marshals:	"SAFETY" / "SPORTBÍRÓ" Yellow or White tabard
Timekeepers:	"CHRONOMOTO" Black shirt

3. ENTRIES

3.1 OPENING AND CLOSING DATES:

OPENING date for ENTRIES:	Thursday, 01. 06. 2023.	10:00 hrs
CLOSING date for <u>REDUCED ENTRY FEE</u> :	Monday, 10. 07. 2023.	24:00 hrs
CLOSING date for ENTRIES:	Monday, 01. 08. 2023.	20:00 hrs

3.2 ENTRY PROCEDURE:

Entries must be made using the online forms on the website www.hungarianbaja.com.

All riders who wish to participate in the event must send the Entry Form, duly completed, along with the proof of payment of the entry fee to the Organizer by e-mail: info@hungarianbaja.com

Each competitor must have a valid FIM Baja World Cup or Cross-Country Rallies World Championship licence in accordance with Art. 70.2.1 of the FIM Sporting Code and Art. 09.1 of the FIM Medical Code. A valid driving licence corresponding to the type and capacity of machine used.

3.3 CLASSES:

CATEGORY 1 – BIKES
CATEGORY 2 – QUAD
CATEGORY 3 – SSV
CLASS 1 – Women
CLASS 2 – Junior
CLASS 3 – Veterans

3.4 ENTRY FEES

3.4.1. With organiser's optional advertising:

EUR 950 **payment transferred** up to closing date with reduced entry fee: **10.07.2023**
EUR 1250 up to entry closing date: 01.08.2023

Without organiser's optional advertising:

EUR 1520 **payment transferred** up to closing date with reduced entry fee: **10.07.2023**
EUR 2000 up to entry closing date: 01.08.2023

The entry fee includes:

- Additional compulsory liability insurance
- Basic service plate/competing vehicle (1pc)
- Basic service area per vehicle (50m²)
- GPS Rental Fee

3.4.2. TO BE PAYED ON SITE:

- **Deposit** for the STELLA GPS navigation and safety tracking system: 100 €
- STELLA GPS navigation and safety tracking system's **Installation Kit** 80 €

3.4.3. OTHER FEES:

- Additional permission to the service park (Assistance sticker / service plate): 100 €
- Additional service area (50m²): 100 €

3.5 PAYMENT

Any entry not accompanied by the entry fee shall be null and void. The entry fee shall be paid by bank transfer to the account indicated below (the adequate proof of payment must be attached to the entry form):

Slovenská Sporiteľna, a.s., Slovakia	Garzone s.r.o
Bank	Account holder
SK2609000000005063476359	GIBASKBX
IBAN	BIC

Payment details: HUNGARIAN BAJA 2023, and full name of the DRIVER

Any entry which is not accompanied with the entry fee will be considered as a preliminary one.

3.6 REIMBURSEMENT

The entry fee shall be refunded in full:

- if the event does not take place
- to teams whose entry application is rejected

The organiser may partially refund entry fees, if a competitor cannot take part in the event due to a duly proved case of force majeure. The deduction will be:

- 50% of the entry fee for the requests received until 20 days before the administrative checks.
- 100% of the entry fee for the requests received less than 19 days before the administrative checks.

3.7 ADMISSION OF DRIVERS

The Organizing Committee reserves its right to reject a competitor's entry without explaining their decision. In order to register at any event of the Bajas World Cup, any driver of any nationality being over 18 years old, must hold a FIM competitor license for FIM Cross-Country Rallies World Championship or Bajas World Cup, valid for the year of the event (art.70.2.1 of the FIM Sporting Code and art. 09.1 FIM Medical Code), released by his NMF, and a driving license corresponding to his vehicle's capacity.

A competitor registering at the HunGarian Baja, does it with full awareness of the risks included in this event. The rider releases in advance to the Organizer, his NMF and FIM by any penal or civil responsibility in case of damages or injuries occurred along his participation at HunGarian Baja.

4. INSURANCE

4.1. THIRD PARTY LIABILITY INSURANCE & RIDERS INSURANCE

As per the FIM requirements:

- Third Part Liability Insurance:

According to the FIM Sporting Code Art. 110.1.1 and FIM Baja World Cup Regulations (Art. 82.5.1) (see 4.3 below)

- FIM Riders' insurance:

Competitors with a valid FIM Licence are covered for Emergency Medical treatment as per the "Information Notice_FIM rider's insurance programme 23-24" (See Appendix 5 of these Supplementary Regulations) and Art. 82.6 FIM Baja World Cup.

4.2. ASSISTANCE VEHICLES, even with Baja ID, may under no circumstances be considered as event participant. Under these conditions, they will not be covered by the event insurance and will circulate under the full responsibility of its owner.

4.3. TRAFFIC INSURANCE: Third party risk insurance (Traffic insurance) is compulsory for all crews taking part in the **Baja**. All competitors must have a traffic insurance policy and present it at the administration checking. This insurance is valid both on road sections and special stages.

European citizens please travel with your European Health Insurance card.

4.4 EVENT INSURANCE:

Name of the insurance company:

SRC SPECIAL RISK CONSORTIUM GMBH, Kuniberts kloster 7-9, D 50668 KÖLN.

The limit of the responsibility is 3.000.000 Eur.

In case of an accident leading to insurance event, the competitor or his representative must make a written statement to the Clerk of the Course, the Competitors Relations Officer, or directly to the Organizer, within 24 hours. This statement must mention the accident circumstances, the names and addresses of the casualties, as well as contact details of the witnesses.

Loss or injury that may be suffered by the drivers themselves or participating vehicles is EXCLUDED. Irrespective of this Third Parties insurance, entrants and drivers are free to take out the policies they deem fit on their own account and at their own discretion. Service vehicles, including those displaying the plates supplied by the Organization, shall under no circumstances be deemed participating vehicles. They are therefore not covered by the Organization's insurance policy and responsibility for them lies solely with their owners. In case of accident, competitors and drivers exempt the event organizers from any liability and waive any right to bring claims against them.

The insurance cover will come into effect from the administrative checking and scrutineering for the Event and end upon the expiry of one of the following time limits, whichever is the later:

- time limit for protests or appeals or the end of any hearing by the Stewards;
- end of the administrative checking and post-event scrutineering;
- end of the prize-giving

5. ADVERTISING / IDENTIFICATION

5.1 COMPETITORS ARE ALLOWED TO AFFIX ANY KIND OF ADVERTISING ON THEIR VEHICLES, IF:

- a) They are authorised by FIM regulations and by the laws of the Country
- b) They are not against public decorum.
- c) They do not prevent the use of the reserved spaces to the number holder plates and to compulsory advertising of the Organization.

5.2 RESERVED SPACES FOR ORGANIZER ADVERTISING:

The logos will be published in Bulletin

1 - Three race number panels with compulsory advertising 20 x 20 cm on each side and on the front of the vehicle

2 - One **baja** plate placed vertically at the front of the vehicle

3 - One race number panel with compulsory advertising 30 x 30 cm to the back of the Riders jacket

Compulsory or optional advertising absent or incorrect affixing will entail a penalty of 50% of the entry fees. In case of repeated offence, it will go up to exclusion.

6. TYRES

According to Art. 47.05 of FIM Bajas Technical Rules.

Only tyres normally available from commercial or retails sources are authorised.

The tyres shall appear on the tyre manufacturers range catalogue or tyre specification lists available to the general public.

The E approval mark and number as defined by the UN Vehicle Regulation R75 must be present on both the front and rear tyre sidewalls.

The DOT approval mark is also accepted.

The number of tyres is limited to one set (front(s) and rear(s)) per race day. When the day is composed of several stages, the tyres could be marked by the FIM Technical Director and/or his appointed crew (art 47.07 FIM Bajas Technical Rules).

7. FUEL

According to Art. 82.9 of FIM Bajas World Cup Regulations

8. ADMINISTRATIVE CHECK

Before Administrative Check, each vehicle must **Register** at the Registration tent, TESCO Parking lot, Várpalota, Fehérvári str.17., where the Checklist and Service Plates will be provided.

8.1 LOCATION: Thury Castle, Hunyadi Mátyás Tér 1., 8100 Várpalota

GPS COORDINATE: N 47° 5'7"E 17°58'10"

8.2 TIMES/ SCHEDULE:

Thursday 10. August 2023. 08:00-15:00

Individual times for each competitor for the administrative checks will be published on Sportity and www.hungarianbaja.com in a Bulletin.

A time control before the Administrative Checks (C1) will be set up, according to the individualized timetable, as well as after the Administrative Checks.

Any delay to the C1 control will be penalized as follows:

- From 1 to 15 minutes: 150€ fine
- From 16 to 30 minutes: 250€ fine
- From 31 to 60 minutes: 500€ fine
- More than 60 minutes: 500€ fine and report to the Stewards.

8.3 DOCUMENTS TO BE PRESENTED:

To minimize the time required for administrative check, please make a photo or scan copies of the documents required, and send them to the following email address: julianna@hungarianbaja.com.

Make sure to bring and present the original of the documents as well:

- Competitor's licence
- Driving licence
- Vehicle's registration document
- Vehicle's compulsory insurance policy
- Authorization (if needed)

9. TECHNICAL SCRUTINEERING

9.1 LOCATION: TESCO, 8100 Várpalota, Fehérvári str.17

9.2 TIME/SCHEDULE: Thursday 10. August 2023 08:00-16:00

Individual times for each competitor for the technical checks will be published on Sportity and www.hungarianbaja.com in a Bulletin.

There will be a time control before the Scrutineering (C3). The competitors should check-in to this time control according the individual schedule.

Any delay to the C3 control will be penalized as follows:

- From 1 to 15 minutes: 150€ fine
- From 16 to 30 minutes: 250€ fine
- From 31 to 60 minutes: 500€ fine
- More than 60 minutes: 500€ fine and report to the Stewards.

9.3 REQUIREMENTS AT TECHNICAL SCRUTINEERING:

- All Vehicles must presented according FIM Bajas Technical Rules 2023
- Vehicles must presented with all start numbers, **baja** plates, and advertisements afixed properly on the designated place.
- Tracking equipment and inter-vehicle signalling system installed and operable even when the ignition removed, it is compulsory to provide 12V
- Scrutineering Sheet- filled up
- Competitor's helmet according art. 01.70 FIM Bajas Technical Rules 2023
- According to art 82.27 of FIM Baja World Cup Regulations: For the entire course, the wearing of an airbag jacket, back and chest protection is compulsory, under pain of disqualification. The airbag system must comply with FIM standards.

The passive protections must be certified as follows:

- Chest: standard EN1621-3
- Back: standard EN1621-2

These protections can be worn separately or combined in a single product.

All Motorcycles/Quads must be according FIM Sound Regulations 2023. **For Bajas World Cup 2023 the Maximum Sound Limit is 117,0 dB/A before the race, and during or after the race is 118,0 dB/A.**

9.4 INSTALLATION OF THE SAFETY TRACKING SYSTEM AND NAVIGATION SYSTEM

9.4.1 TRACKING AND NAVIGATION SYSTEM (NAV-GPS)

All vehicles must only be fitted with the Safety Tracking System(s) provided by the Organiser. The instructions for the use of the Tracking System is in the Appendix 5 of this Supplementary Regulations. Delivery and installation of the equipment will be carried out right before the administrative checks. Every competitor must return the equipment at the end of the competition, or, if a crew retires- to the STELLA Crew.

9.4.2 CONNECTION OF THE SYSTEMS

It is the competitor's responsibility to ensure that the Safety Tracking System and the NAV-GPS always remain permanently connected and switched on with the antenna connected throughout the duration of the competition.

9.5 PARC FERMÉ

Following the technical scrutineering, each vehicle must be set in Parc Fermé up to 15:00-18:30.
Location: Szabadság Tér, 8100 Várpalota.

According to Art 82.25 FIM Baja World Cup Regulations 2023.

- The access to the Parc Fermé is forbidden to everyone except the FIM, FIM Europe and MAMS Jury Members, Technical Stewards, Clerk of the Course, Environmental Stewards, Tracking System

Operators, Parc Fermé Officers, and competitors. Competitors only have access to Parc Fermé to place and remove their vehicles. The operation shall be carried out without delay, and the riders shall leave the Parc Fermé as soon as possible.

- In the parc fermé is compulsory wear an Environmental Mat underneath Motorcycles/Quads/SSV in order to protect the ground from dropping liquids (oil, chain spray, fuel, etc..).
- The minimum dimensions of the Mat must be at least equal to the wheelbase of the motorcycle/Qual/SSV, and the width of the handlebars for motorcycles, or the track wheels width for Quads/SSV.
- This Mat Must be composed of a waterproof sole and an absorbent textile.
- In the Parc Fermé, it is forbidden for a competitor, under penalty of disqualification (or other penalties given as provided for in the FIM Disciplinary and Arbitration Code) from the event: • to refuel; • to make any repairs; • to touch the motorcycle/SSV of any other competitor.
- As an exception to the Parc Fermé status, but subject to the responsibility of an official, a competitor may, in the Parc Fermés for starting, regrouping and end of Stage, change or overhaul, by his own means, a damaged headlight or rear lights. These repairs must be fully completed before the starting time.
- Vehicles will be removed from Parc Fermé only with permission of the Clerk of the Course.

10. START OF THE EVENT

10.1 PUBLICATION OF START LISTS: According to Programme.

10.2 BRIEFING:

LOCATION: Thury Castle, Hunyadi Mátyás Tér 1., 8100 Várpalota

TIME: Thursday 10.08.2023 at 19:00

Briefing is compulsory for each competitor, who must confirm his presence by signature.

10.3 ROAD BOOK PROVIDING:

- At Administrative Checks: Road Book for Shakedown Stage.
- At Briefing: Road Book for Stage1: 19:00
- Entering Park Fermé at the end of Stage1: Road Book for Stage2

The use of the road book provided by the organizer (printed) is mandatory at the event.

11. RUNNING OF THE EVENT

11.1 PARC FERMÉ BEFORE THE OFFICIAL START

In Start Parc Fermé, crews should be ready 15 minutes before the individual ideal starting time.

11.2 TIME CARD PROVIDING/EXCHANGES

Time cards will be issued before the Start of each Section, wich must be submitted to the marshalls at the Finish of each Section.

Time card exchanging: at regrouping.

11.3 STARTING PROCEDURE FOR THE SECTIONS will be as follows:

The start of the Section is happening based on an electric clock and lamp, connected to a false start alert system. A digit display will show continuously the time progressing.

The Marshalls will call out loud the 30, 15, 10 seconds then point towards the start equipment. Beginning from the 55 seconds, red lights will be flashed per every second, then at 00 seconds the red lights will go off and below, the green lights will go up. This will be the time to start.

In case the equipment goes wrong, the marshals will change to manual starting procedure.

PUBLICATION OF START LIST:

Digital Notice Board: [Sportity](https://www.sportity.com), www.chronomoto.hu, www.hungarianbaja.com

11.4 CLOSED CONTROL

Control post must be ready to function 1 hour before the target time for the passage of the first crew. Unless the clerk of the course decides otherwise, they will cease to operate 1 hour after the target time for the last crew, plus the maximum time allowed for the last competitor.

Any crew with a delay higher than 30 minutes at any time control, will have the start refused for the following section, but will not be eliminated from the event.

Penalty to be imposed will be:

30 minutes for the delay in this control, adding the penalty for not taking the Start in the following SS, and adding the maximum time authorized for the selective section not completed.

Example:

Sector

Maximum time allowed: 01h 00'

Case 1 – Competitor n°1	Start	C.H.1	12h 00 '	
	Arrival	C.H.2	13h 00 '	penalty = 0'
Case 2 – Competitor n°1	Start	C.H.1	12h 00 '	
	Arrival	C.H.2	13h 30 '	penalty = 30'
Case 3 – Competitor n°1	Start	C.H.1	12h 00 '	
	Arrival	C.H.2	13h 31 '	penalty = 30' + penalty for not taking Start in following S.S. + maximum time allowed for following S.S.
Case 4 - Competitor n°1	Start	C.H.1	12h 00 '	
	NO ARRIVAL TO C.H.2'			penalty = 30' + penalty for not taking Start in following S.S. + maximum time allowed for following S.S.

11.5. EARLY CHECK-IN AT END OF LEG

Early-check in is allowed at TC2C and TC4A

11.6. It is strictly forbidden to enter or leave a control area from any direction other than specified by the Road-Book, or to re-enter a control area once checking in has taken place at this control.

11.7. RECONNAISSANCE

Reconnaissance of the route including the Prologue is totally forbidden. Possession of route notes or other informations different from those given by the Organization is forbidden. Penalty decision at Jury's discretion.

The only official route is that provided by the Organizer: printed Road-Book.

To help competitors, the Organizer will indicate intersections and features of the route by means of arrows and tapes. The Road-Book shall be the only official document to be followed.

12. FIXED PENALTY

TIME CONTROLS – MAXIMUM TIME ALLOWED – PENALTIES

A maximum lateness of 30 minutes for every Road section and a total lateness of 30 minutes in road sections of a Stage is authorised. This lateness will be penalised at a rate of 1 minute per minute or fraction of minute according the Art. 38.8 of General Prescriptions 2023.

For each Selective Section a maximum time authorised for the respective Sections will be the following:

	FRIDAY			SATURDAY	
TIMES ON SELECTIVE SECTIONS	PROLOGUE 9,5 HH:MM	SS2 114,16 HH:MM	SS3 114,16 HH:MM	SS4 125,41 HH:MM	SS5 125,41 HH:MM
Maximum time Finish in the Maximum time	00:30' Time taken	03:00' Time taken	03:00'	03:00' Time taken	03:00'
Started, but not finished in the maximum time	00:30'	04:00'	04:00'	04:00'	04:00'
Not Starting	01:00**	06:00***	06:00***	06:00***	06:00***

* Subject to approval by the Stewards and force majeure.

** You must have taken start at that Leg.

Maximum time allowed may be modified by the Stewards upon the proposal of the clerk of the Course in case of non - predictable circumstances (climate, modifications in section distance, etc..)

This penalty is only applicable to crews, who:

- Complete at least 50% of the number of the selective sections of the race.
- Have started on every Leg.

If any of the above requirements are not met, the competitor is excluded from the event.

* OTHER PENALTIES	H:M:S
For each CP passage missing, * if the crew have take the start	1:00:00
For each CP stamp missing, * if the crew have take the start	0:30:00

* These penalties shall be added to the time of the corresponding SS to obtain the total time elapsed.

13. SERVICE PARK

13.1 LOCATION:

GÁL GYULA SPORS HALL parking lot (with shower and toilet facility in the Sports Hall)
8100. Várpalota, Fehérvári str. 9.

Servicing a competing vehicle will be permitted only at service areas specified by the Organization. Repairs that may be carried out by a team using on-board equipment or equipment carried by another participant in the race are authorized along the whole route. Any other external servicing outside the authorized areas is forbidden and shall be penalized by EXCLUSION at the Jury's discretion.

13.2 ACCESS TIMES FOR SERVICE VEHICLES

According to Programme.

13.3 OPERATION OF THE SERVICE AREAS

Entry will be permitted only to Service Vehicles showing the Service Plates. Accompanying team cars can enter only by purchasing a 100€ sticker at the Administrative Checks. Tampering with or falsification of the Service Plates will lead to disqualification of the team to which these service vehicles belong.

The Service Plates will be placed in a visible area of the front windscreen of the vehicle. Each crew will receive **one** Service Plate **free**.

The maximum speed allowed in the service parks is 30 km/h

In the service areas/refuelling is compulsory wear an Environmental Mat underneath Motorcycles/Quads/SSV in order to protect the ground from dropping liquids (oil, chain spray, fuel, etc..).

The minimum dimensions of the Mat must be at least equal to the wheelbase of the motorcycle/Qual/SSV, and the width of the handlebars for motorcycles, or the track wheels width for Quads/SSV.

This Mat Must be composed of a waterproof sole and an absorbent textile.

The engine must be stopped during refuelling.

During the refuelling, each team must have a portable extinguisher (A.B.C. polyvalent powder) of 5 kg minimum, in the proximity of the refuelling post (max. 5 m distance).

Each service team has to ensure that after carrying out their activities on the site, they do not leave any pollutants. They will be checked by the scrutineers, and not complying will entail a 50.000HUF fine.

Washing and Refuelling is strongly prohibited in the total area of the Service Park!!!

The Organizer calls the attention of the participants, that the Service Park is not guarded at night time!

13.4 REFUELLING

Refuelling is permitted only in commercial fuel stations using fuel on sale to the public. Only the crew may carry out this procedure.

On SS1A, SS1B, SS2A, SS2B, SS3A, SS3B, SS4A, SS4B will be a Neutralization Zone for all Competitors and a separate Remote Refuelling Zone (RRZ) for Motorcycles, Quad, and SSV vehicles only.

The Refuelling station authorised will be indicated in the Road Book with "FUEL STATION".

In here, compulsory to use an Environmental Mat underneath Motorcycles/Quads/SSV.

14. FINAL CHECKS / PROTEST / APPEALS

14.1. FINAL CHECKS

Time and location: see Programme

Any teams required to undergo final checks must immediately follow the instruction of the marshals in charge, even if this prevents them from proceeding to one or more time controls (TC).

14.2. PROTEST

Any complaint shall be presented according to requirements of the Disciplinary and Arbitration Code. They must be submitted by writing to the Clerk of the Course, within the required dates, by the concerned competitors and not by third parties.

Protest deposit: 660€

15. RESULTS

The Provisional overall classification will be published:

Digital Notice Board: Soportity, www.chromoto.hu, www.hungarianbaja.com

16. PRIZES

16.1 PRIZE GIVING CEREMONY

LOCATION: Várpalota Főtér, Szabadság Tér

TIME: Saturday 12. August 2023 18:00

16.2 PRIZES:

FIM CATEGORY (1 / 2 / 3) - 1st to 3rd CUPS

FIM CLASSES (1 / 2 / 3) - 1st to 3rd CUPS

The organizer can foresee other prizes too.

Prize giving for the National Open Event will be held according to the MAMS regulations of this series.

The prizes will only be given to these Categories, Groups and Classes, if there is a minimum of 5 participants at the start, otherwise only the first given prizes.

At the entire route of the event, the national traffic rules must be respected.

FIM approval:
MAMS Nr: MAMS/049/2023
EMN Nr: 34/325
IMN Nr: 814/05

APPENDIX 1. – COMPETITOR RELATIONS OFFICERS

Name and photograph of the Competitors Relation Officer and schedule



(ENG + DEU)
Mr. István MÁTRAI
+36 20 417 6249

Estimated working plan:

Thursday 10. August	Admin check Scrutineering Briefing / Start TC / Start Ceremony	08:00 – 15:00 08:00 – 18:00 19:00 – 21:00
Friday 11. August	Parc Fermé / Service area	08:30 – 22:30
Saturday 12. August	Parc Fermé / Service area Finish Ceremony	08:30 – 18:00 19:00

APPENDIX 2. – TIMETABLE



XX. HUNGARIAN BAJA

MOTO

Stage 1								2023.08.11. FRIDAY / PÉNTEK	
Sunrise 5:29								20:17	Sunset
IE/TC	Location	SS	SS	Liasion	Total	Target	1st vehicle		
SS		Maximum Time	Km	Km	Km	Time	Due		
TC0A	VÁRPALOTA Parc Ferme OUT						9:30		
TC0B	Várpalota			3,33	3,33	0:10	9:40		
DSS P	PROLOGUE START					0:05	9:45		
ASS P	PROLOGUE FINISH	0:30	9,47		12,80	(0:08)	(9:53)		
	Várpalota					(Expected time of arrival)			
TC0C	Service IN			6,73	19,53	0:10	10:03		
SERVICE A									
TC0D	Service OUT			0,83	20,36	0:15	10:18		
Refueling, Petrol Station,									
TC0E	Regrouping IN			0,51	20,87	0:15	10:33		
REGROUPING									
TC0F	Regrouping OUT						10:40		
TC1	Várpalota			2,76	23,63	0:10	10:50		
DSS 1A	START					0:05	10:55		
ASS 1A	FINISH	1:30	52,67		76,30	(0:42)	(11:37)		
	Gyulafirátót					(Expected time of arrival)			
Neutralization zone									
	Gyulafirátót			1,38	77,68	0:15	11:52		
DSS 1B	START						11:52		
ASS 1B	FINISH	1:30	57,99		135,67	(0:46)	(12:38)		
	Újmajor					(Expected time of arrival)			
Refueling, Petrol Station,									
TC1A	Service IN			31,50	167,17	0:50	13:28		
SERVICE / SZERVIZ B									
TC1B	Service OUT			0,83	168,00	0:30	13:58		
TC1C	Regrouping IN			0,51	168,51	0:05	14:03		
REGROUPING									
TC1D	Regrouping OUT						14:30		
TC2	Várpalota			2,76	171,27	0:10	14:40		
DSS 2A	START					0:05	14:45		
ASS 2A	FINISH	1:30	52,67		223,94	(0:42)	(15:27)		
	Gyulafirátót					(Expected time of arrival)			
Neutralization zone									
	Gyulafirátót			1,38	225,32	0:15	15:42		
DSS 2B	START						15:42		
ASS 2B	FINISH	1:30	57,99		283,31	(0:46)	(16:28)		
	Újmajor					(Expected time of arrival)			
Refueling, Petrol Station,									
TC2A	Service IN			31,50	314,81	0:50	17:18		
SERVICE / SZERVIZ C									
TC2B	Service OUT			0,83	315,64	1:20	18:38		
TC2C	Parc Ferme IN / Early Check-IN is Authorised			0,51	316,15	0:05	18:43		
Day Total			221,32	85,36	316,15				
			70,00%	27,00%	100%				



XX. HUNGARIAN BAJA

MOTO

Stage 2 2023.08.12. SATURDAY / SZOMBAT

Sunrise 5:30 20:15 Sunset

IE/TC SS	Location	SS Maximum Time	SS Km	Liasion Km	Total Km	Target Time	1st vehicle Due
TC2D	Parc Fermé OUT						8:00
	Refueling, Petrol Station,						
TC3	Újmajor			29,81	29,81	0:45	8:45
DSS 3A	START					0:05	8:50
ASS 3A	FINISH	1:30	58,30		88,11	(0:47)	(9:37)
	<i>(Expected time of arrival)</i>						
	Neutralization zone						
	Gyulafirátót			1,38	89,49	0:15	9:52
DSS 3B	START						9:52
ASS 3B	FINISH	1:40	64,50		153,99	(0:51)	(10:43)
	<i>(Expected time of arrival)</i>						
TC3A	Service IN			3,95	157,94	0:10	10:53
	SERVICE / SZERVIZ D						
TC3B	Service OUT			0,83	158,77	0:40	11:33
	Refueling, Petrol Station,						
TC3C	Regrouping IN			0,51	159,28	0:20	11:53
	REGROUPING						
TC3D	Regrouping OUT						12:15
TC4	Újmajor			29,81	189,09	0:45	13:00
DSS 4A	START					0:05	13:05
ASS 4A	FINISH	1:30	58,30		247,39	(0:47)	(13:52)
	<i>(Expected time of arrival)</i>						
	Neutralization zone						
	Gyulafirátót			1,38	248,77	0:15	14:07
DSS 4B	START						14:07
ASS 4B	FINISH	1:40	64,50		313,27	(0:51)	(14:58)
	<i>(Expected time of arrival)</i>						
TC4A	Parc Ferme IN / Early Check-IN is Authorised			3,95	317,22	0:15	15:13

Section 4

Section 5

Day Total	245,60	71,62	317,22
	77,42%	22,58%	100%

	SS km	Liasion km	Total km
Rally Total	466,92	156,98	633,37
	73,72%	24,78%	100%



MAIN SCREEN

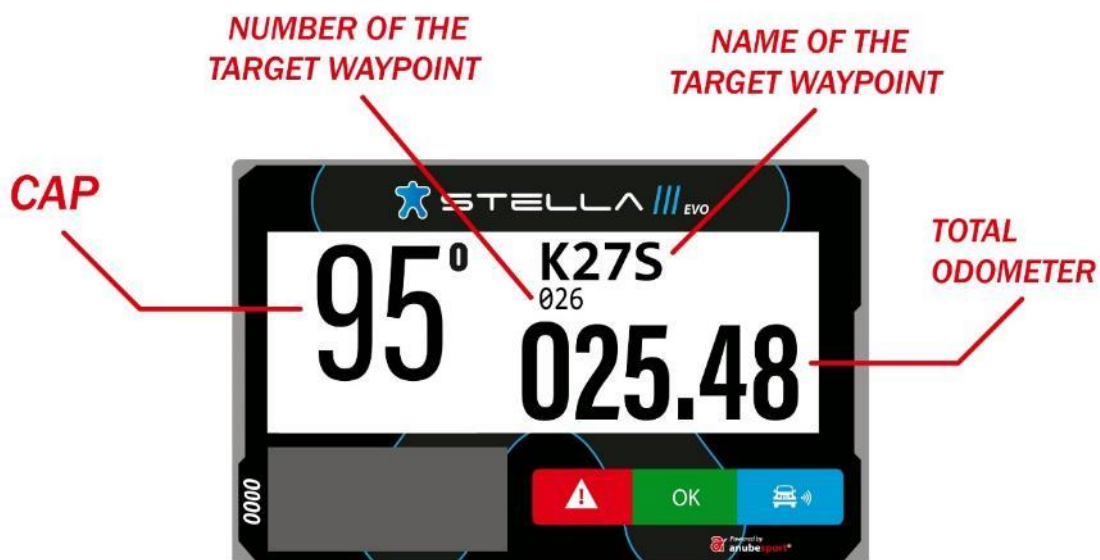

WAYPOINT PROXIMITY



SPEED ZONE

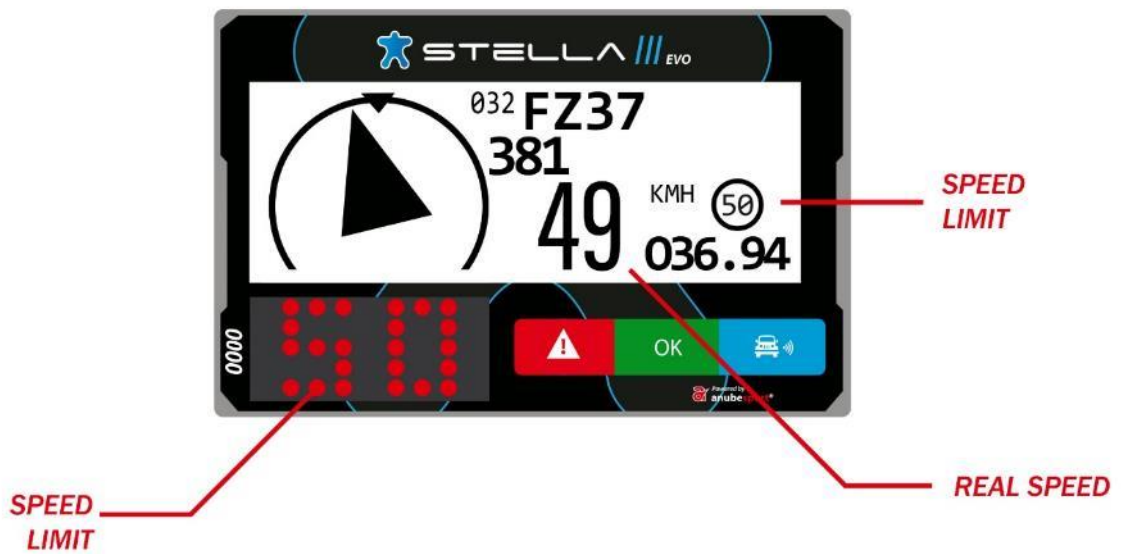

REQUEST MEDICAL ATTENTION IMMEDIATELY

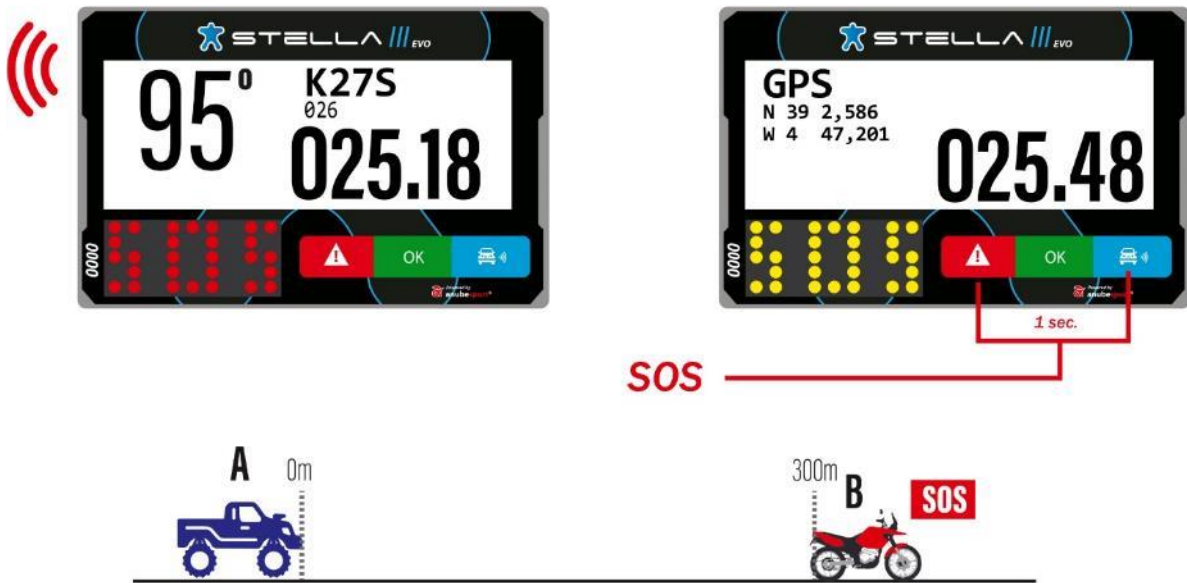

CAUTION VEHICLE STATIONARY

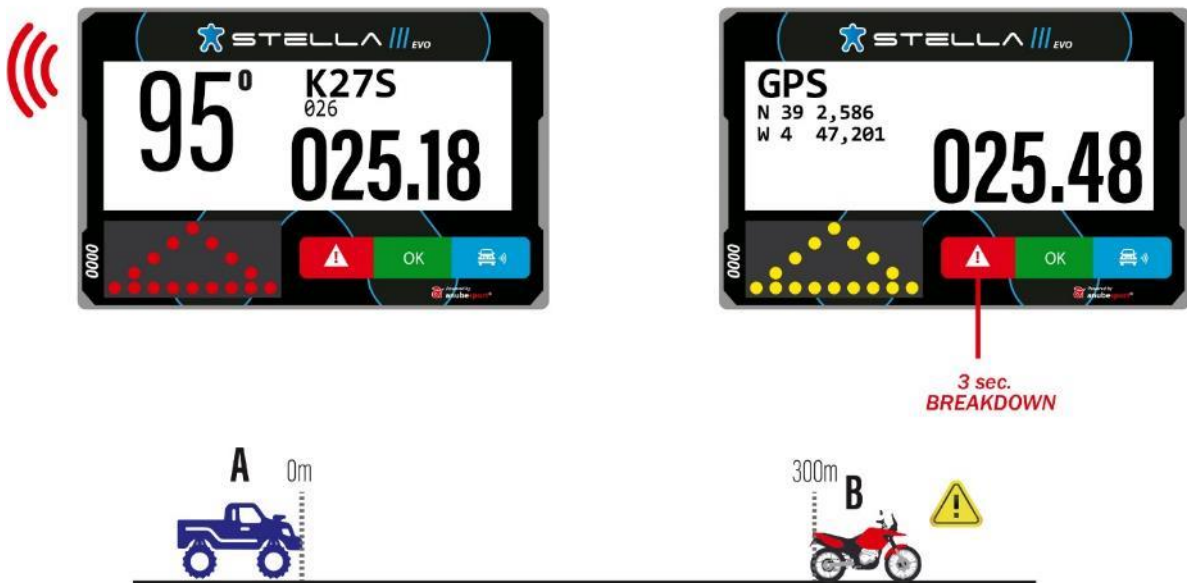

DANGER 3 !!!



Notification 300m before an area marked in the roadbook as "Danger 3"

OVERTAKING / BLUE FLAG



OVERTAKING / BLUE FLAG



STEADY



FLASHING



OVERTAKING / BLUE FLAG



FREE TO OVERTAKE



STEADY

PRESS THE BLUE BUTTON TO CONFIRM

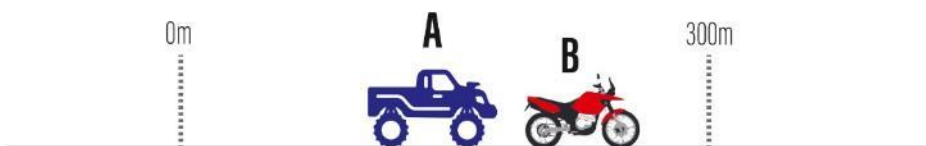

SPEED LIMIT



SPEED LIMIT



YELLOW
90m on approaching speed zone

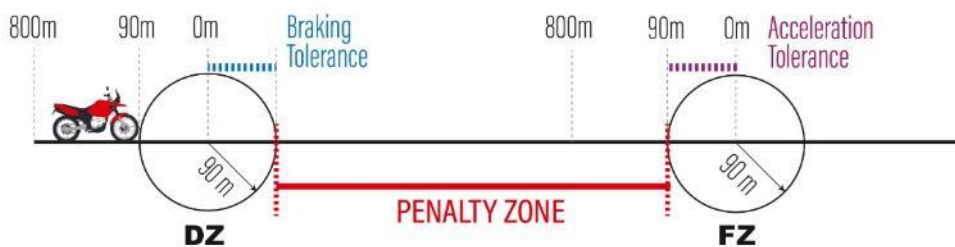

SPEED LIMIT

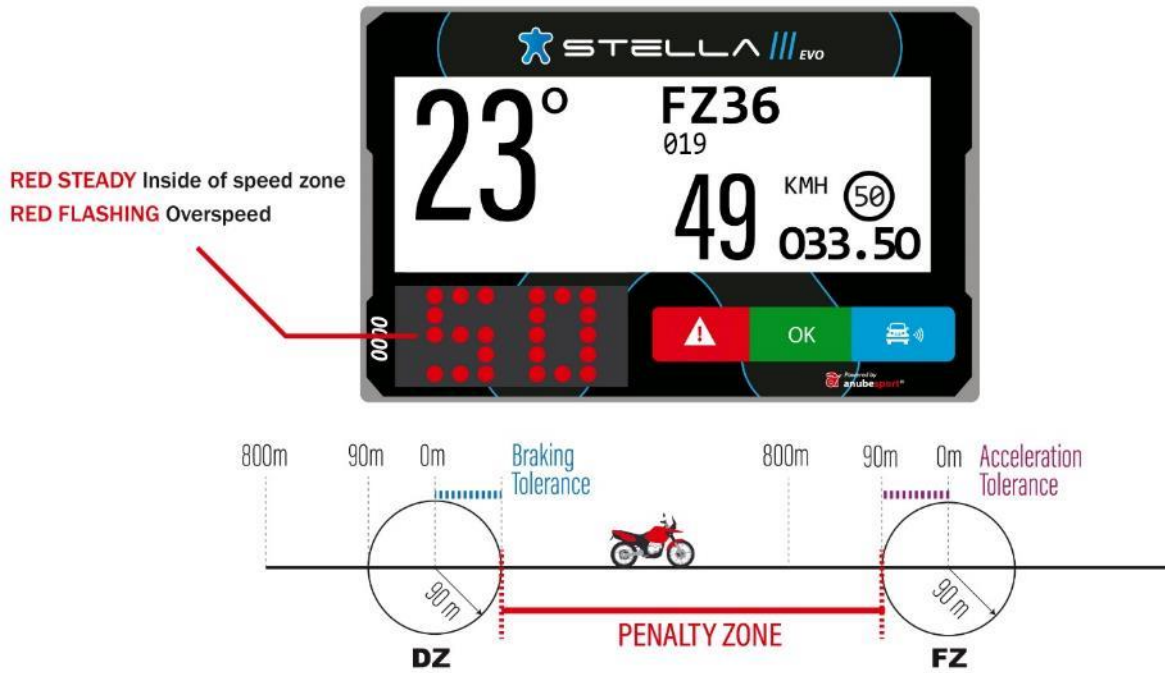

SPEED LIMIT

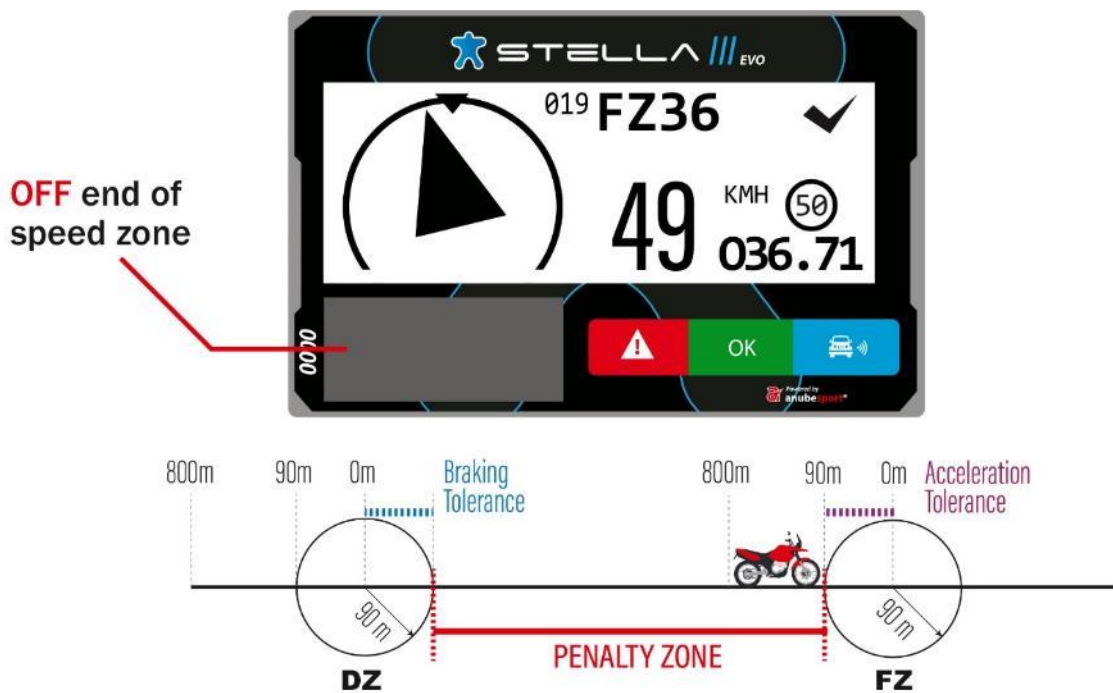

NEUTRALIZATION ZONE

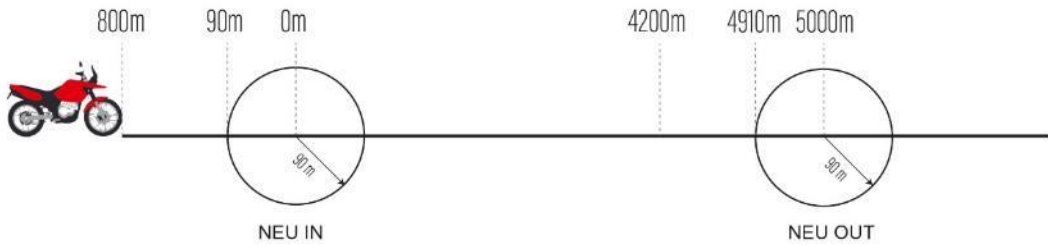

NEUTRALIZATION ZONE

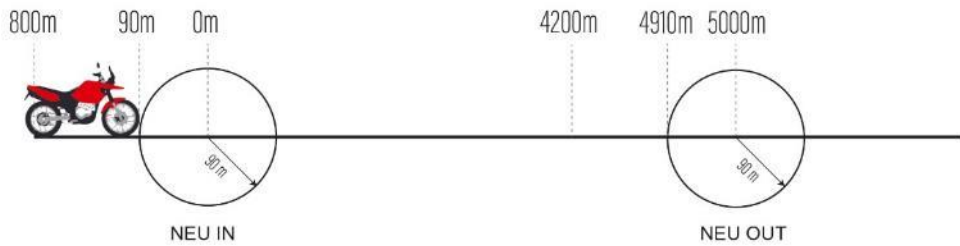

NEUTRALIZATION ZONE

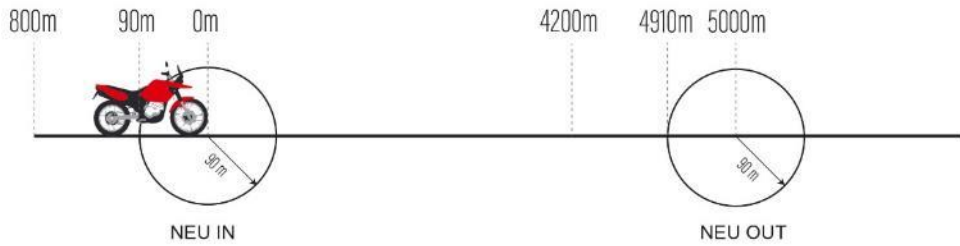

NEUTRALIZATION ZONE

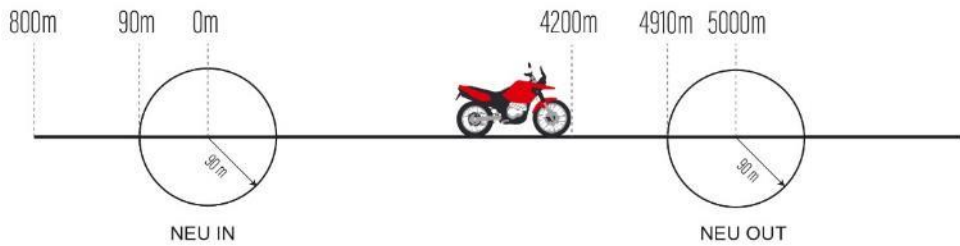

NEUTRALIZATION ZONE

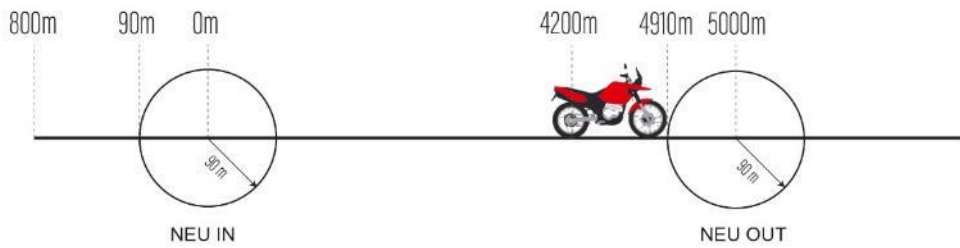

NEUTRALIZATION ZONE

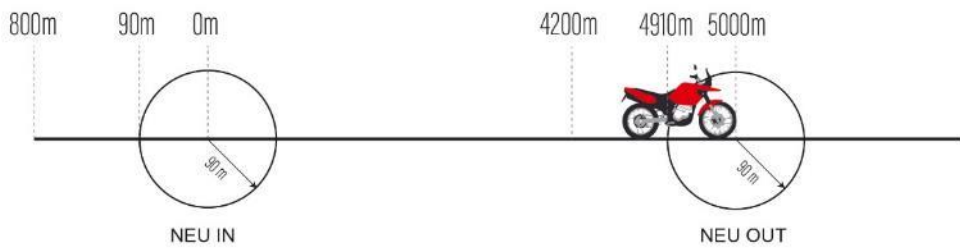

MESSAGES

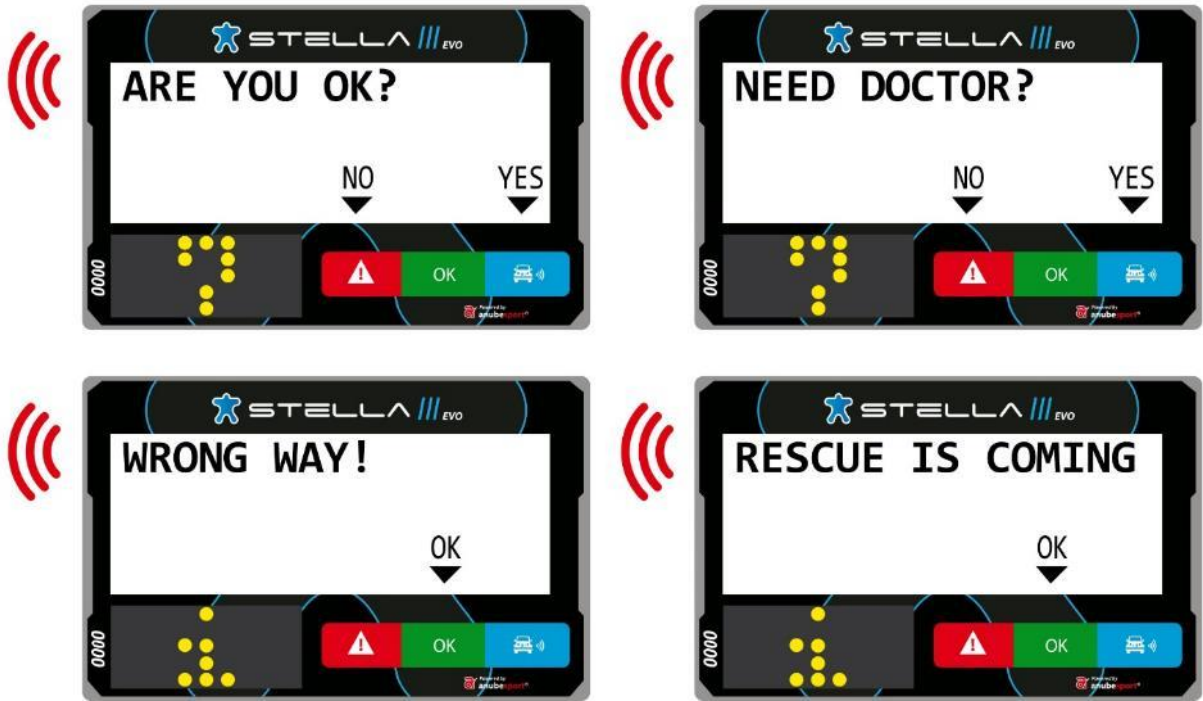

WAYPOINTS LIST



TOTAL ODOMETER RESET TO ZERO



OK

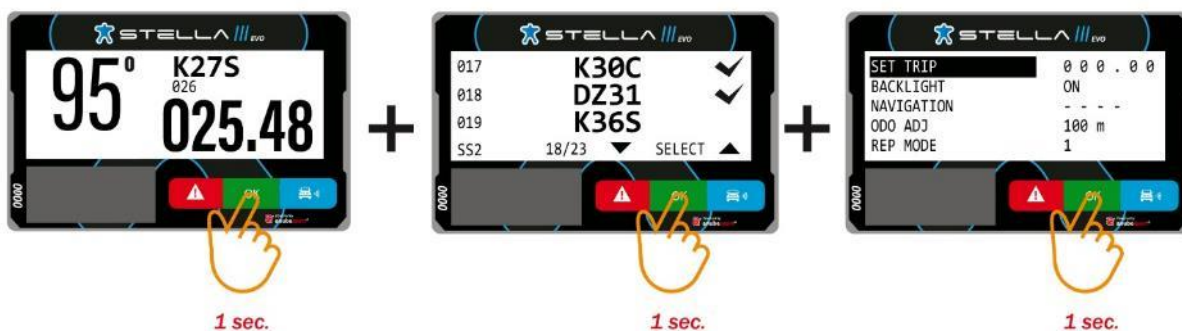

APPENDIX 4. – GPS TRACKING SYSTEM'S INSTALLATION KIT

KIT COMPONENTS 80€



1. Iridium Antenna
2. Power Cord
3. RF Cord
4. RF Antenna
5. Base/Mount
6. GPS Antenna
7. Adhesive
8. Straps
9. User Manual

IMPORTANT

For the functional tests and verification, all vehicles must have gone through the installation of the mount, power cord, and antennas.

1. POWER CORD

- Connect the red wire to the positive end of the battery 12V(+), and the grey wire to the negative end (GRD). The power cord must be connected directly to the battery (without interruptions and without contact in the power supply).
- A 3A fuse (not included) should be connected to the red wire.
- Take the cord to the location in which the STELLA III EVO is to be installed. All other wires must be insulated, they cannot touch.



2. BASE/MOUNT

- Motorcycles and ATV: The mount can be attached to the handle bar or to a metal plaque close to the navigation system.
- Cars and UTV: The mount can be attached to the panel, or to the roll cage bars. STELLA III EVO buttons must be visible and accessible to the participant (pilot/navigator) even when they are sitting and with the seatbelts buckled.

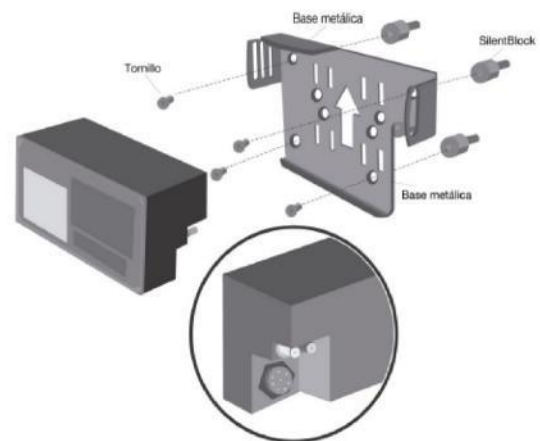

IMPORTANT

Leave the cords (antenna and battery) in place with at least 10 cm to spare for easy handling.

At least 5 cm of space behind the mount (bottom right corner) to allow space for power cord/connections.

3. GPS ANTENNA

The GPS antenna must be installed horizontally and without obstructions toward the sky. In cars and UTV, It can be mounted on the roof, the hood, or the dashboard. In motorcycles and ATV, attach to the mudguard. For additional firmness, it is recommended to cover it with adhesive tape (non metallic when mounting it to a metallic surface) and pull-up (when attached to soft or plastic parts).



4. ANTENNA IRIDIUM

The Iridium antenna must be installed horizontally and without obstructions toward the sky. In cars and UTV, It can be mounted on the roof, the hood, or the dashboard. In motorcycles and ATV, attach to the mudguard. For additional firmness, it is recommended to cover it with adhesive tape (non metallic when mounting it to a metallic surface) and pull-up (when attached to soft or plastic parts).



5. RF ANTENNA

The radio-frequency antenna must be installed vertically to the roll cage bars (cars and UTV) and the forks (motorcycles and ATV). It is mandatory to use separators (included in the kit) to avoid contact with metallic parts and the carbon fibre that surrounds it.

Once the antennas are mounted, take the SMA connection cords to the base/mount where the STELLA III EVO will be installed.





FIM Riders' insurance information

The rider's insurance policy set up by the FIM is a service for all the Federations that are part of the programme for the period from January 1, 2023 to December 31, 2024.

Who is covered:

- Riders with a FIM licence issued by a Federation which is part of the FIM riders' insurance programme.
- Riders with a FIM licence issued by ACCR, DMSB, FMS, KNMV, NMF and SMF are not part of the FIM riders' insurance programme and must follow the guidelines of their respective Federation.
- Riders competing in MotoGP, Moto2, Moto3 and MotoE are not part of the FIM riders' insurance programme and must follow the guidelines of their respective Federation.
- Riders competing in a Cross Country Rally must follow the guideline of the Rally organiser.

Validity of the insurance:

- For all events on the FIM Calendar with an International Manifestation Number (IMN).
- For racing activities included in the official programme of the event only!
- - Travel to and from the event venue.

Scope of coverage:

In case of racing incident, the FIM riders' insurance programme would cover:

- Emergency Medical treatment on the event's place (subsidiary and complementary to any other insurances the rider may hold)
- Repatriation to the rider's country of residence (as declared on the FIM Licence extranet by the rider's FMN)
- Death and Disability (Riders with a FIM licence issued by FFM and FMI have not subscribed this benefit from the FIM riders' insurance programme and must follow the guidelines of their respective Federation for this benefit)

Please note that this is an EMERGENCY insurance and in order to avoid any problems please follow the correct procedure.

What to do?

Before departure:

- Always check beforehand whether your personal health insurance card is still valid.
- For European citizens, please travel with your European Health insurance card.

In case of an Emergency Incident /Urgent medical assistance need:

- Contact the FIM insurer immediately before any action whatsoever
 - 24/7 Emergency Contact number:
+44 (0) 208 608 4227
 - 24/7 Emergency Email Contact:
internationalhealthcare@healix.com



For pay & claim, invoice reimbursement and administrative support

- Contact the FIM Insurer payment and general assistance team
 - Contact telephone number:
+44 (0) 1702 553443
 - Payment and general assistance email contact
FIMclaims@csal.co.uk
 - Postal contact
CSA Ltd – FIM Claims
308-314 London Road
Hadleigh
Essex
United Kingdom
SS7 2DD

When contacting any of the claims team you will need to provide:

- Your FIM licence number and your contact details
- The FIM event number: IMN
- The venue of the event

Important notes:

- When you are being transported to hospital for medical examinations treatment and/or assessment:
 - Always take your documents related to your personal health insurance and to the FIM riders' insurance programme when you are being transported.
 - When receiving medical assistance at the event/hospital:
 - You/a nominated representative must always receive a complete clinical record of all medical examinations, treatment and assessment.
 - Always provide the insurance file number provided to you during your first call.
 - Make sure your Federation indicates the correct country of residence in your details and your correct emergency and authorized contact persons. Any repatriation will be to the address/country provided by your Federation on the FIM Extranet site.
 - The FIM riders' insurance programme is only valid at FIM-approved events with a valid Number (IMN). If you are attending private test and/or non-event practice days, YOU WILL NOT BE COVERED by the FIM insurance.
 - Always follow the instructions or you may no longer be covered by the FIM riders' insurance programme!
 - Please ensure you agree upon any medical care or medical arrangements with the FIM insurer before taking any action whatsoever!
-
- **Do not delay in contacting the emergency helpline. Make the call as soon as you can to advise of your accident!**
 - **Do not change or leave the hospital, before contacting the emergency claims line, or the FIM insurance services may not be provided.**
 - **Do not leave the country in which the incident occurred, before contacting the emergency claims line, or the FIM Insurance services may not be provided.**



Benefits table:

ASSISTANCE GUARANTEES	CEILING
- Medical expenses (in addition to and/or in substitution of any public or private supplemental plan) (A)	(A) 400,000.00 EUR In the absence of a public or private supplemental plan, the guarantee is capped at EUR 125,000.00 Cross-Country Rally licence excess 10,000 EUR (30,000 EUR at the Dakar)
- Expenses for search and rescue (B)	(B) 50,000.00 EUR Cross-Country Rally licence excess 40,000 EUR
- Repatriation or medical transport (C) Medical evacuation Repatriation for medical reasons	(C) Real costs
- Dispatch of a doctor on site (D)	(D) Real costs
- Monitoring of inpatient and outpatient care (E)	(E) Real costs
- Repatriation of remains Repatriation of remains (F1) Funeral expenses necessary for transport (F2) Assistance with death formalities (F3)	Telephone assistance (F1) Real costs(F2) Real costs(F3) Real costs
- Repatriation of an accompanying person (G)	(G) Real costs
- Visit of family member/close friend (H)	(H) 5,000.00 EUR
- 24/7 medical advice (I)	(I) Telephone assistance
- Access to the network of medical providers(J)	(J) Telephone assistance
- Second medical opinion (K)	(K) Telephone assistance
- Dispatch of medication (L)	(L) Shipping costs
- Linguistic assistance (M)	(M) Telephone assistance
- Psychological support (N)	(N) 2 telephone consultations
- Early return (O)	(O) 10,000.00 EUR
- Extension of stay (P)	(P) 1,900.00 EUR
INDIVIDUAL ACCIDENT (IF OPTION SUBSCRIBED)	
- Accidental death (Q1)	(Q1) 50,000.00 EUR
- Total permanent infirmity following an accident (Q2)	(Q2) 50,000.00 EUR If permanent disability greater than 55%, then compensation = 100% of the insured capital

Appendix 6. SPORTITY APP / DIGITAL NOTICE BOARD

The organizers will employ the use of Sportity mobile app to host all the sporting documents for the entire event. Please enable notifications on the app after you install it to ensure you receive the latest notifications when documents are uploaded.

This may include but is not limited to the following.

- Baja Guide
- Supplementary Regulations
- Moto Itinerary
- General and Safety Briefing Notes
- Bulletins
- Maps/Layouts
- Entry lists
- Documentation and Scrutineering Schedules
- Starting lists
- Provisional Classifications
- Penalties
- Road book modifications

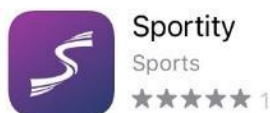

OPEN

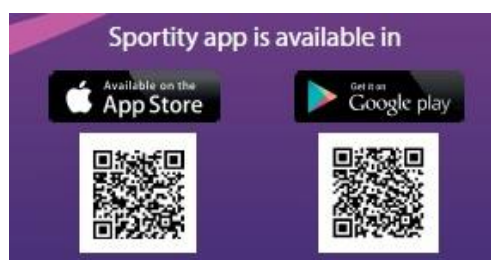
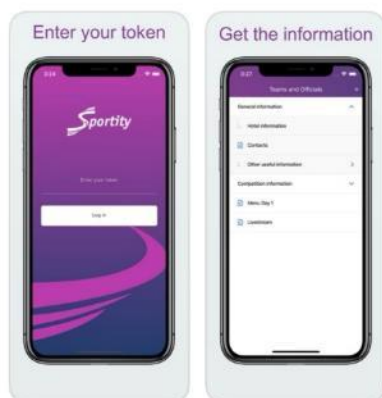

Appendix 6 ITEMS AT THE ORGANISERS' DISCRETION

After the Prize Giving Ceremony, we are delighted to announce that a jubilee party will be held in celebration of the XX-th Hungarian Baja, and we warmly invite everyone to join us. We kindly recommend making accommodation arrangements accordingly.

We wish everyone a safe and accident-free competition!